

# COVER: 6 SURFACE

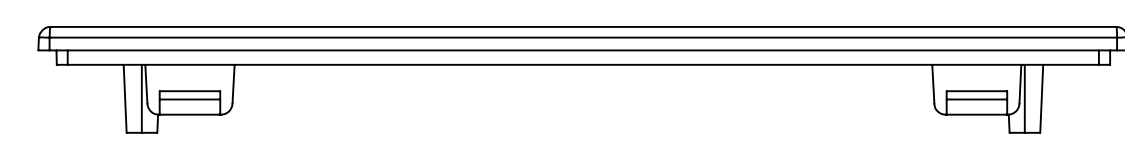

SURFACE-1

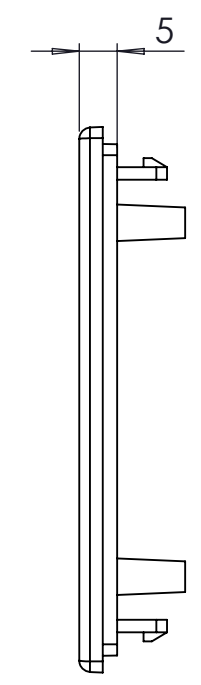

SURFACE-3

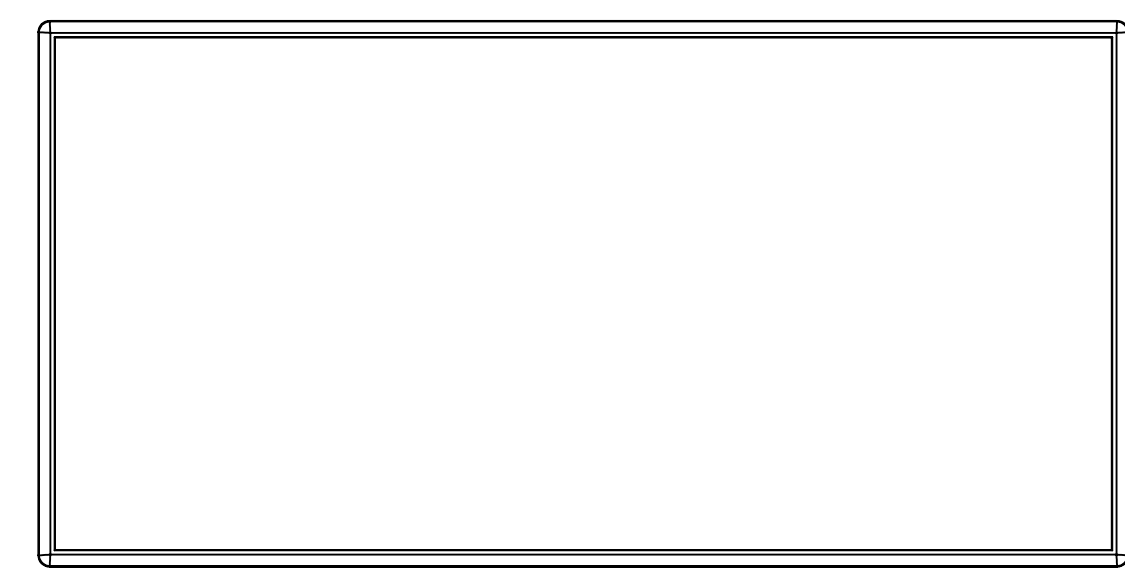

SURFACE-5

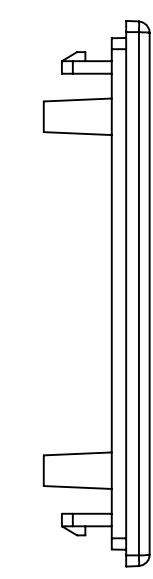

SURFACE-4

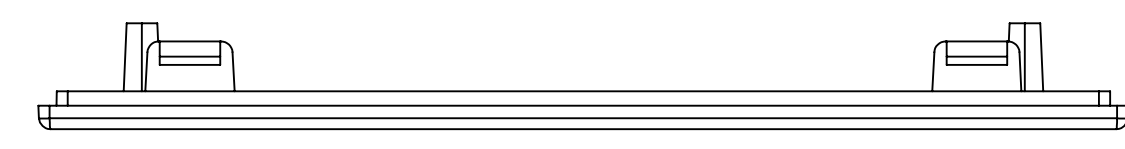

SURFACE-2

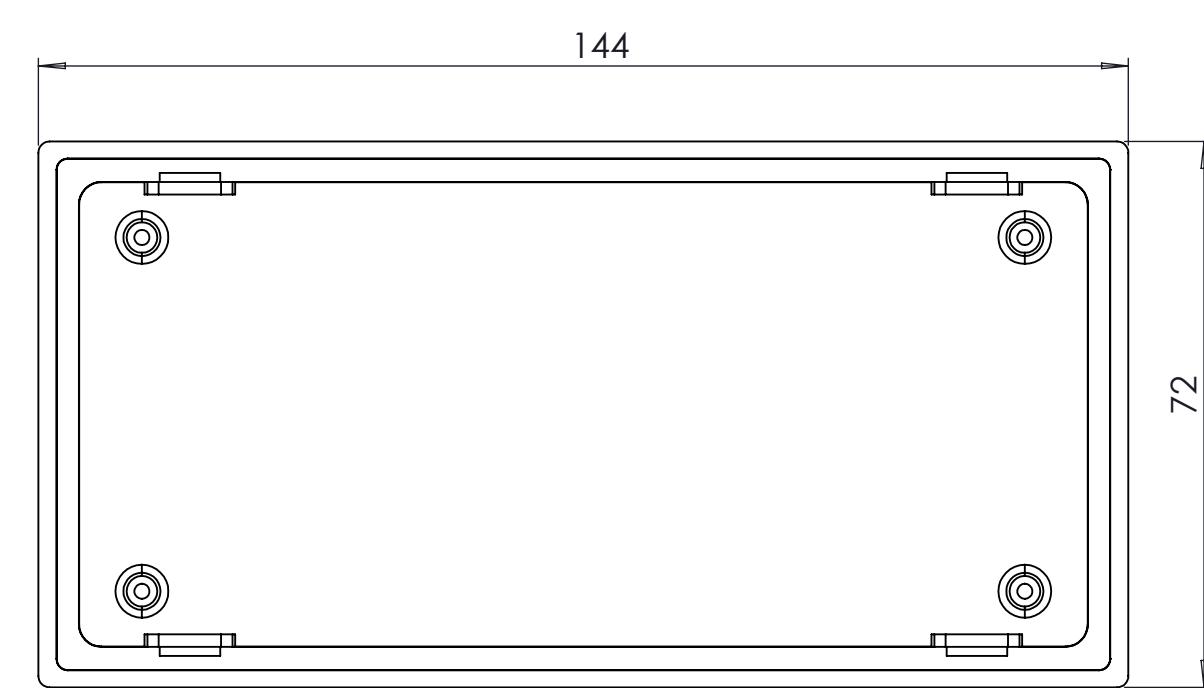

SURFACE-6 (INSIDE)

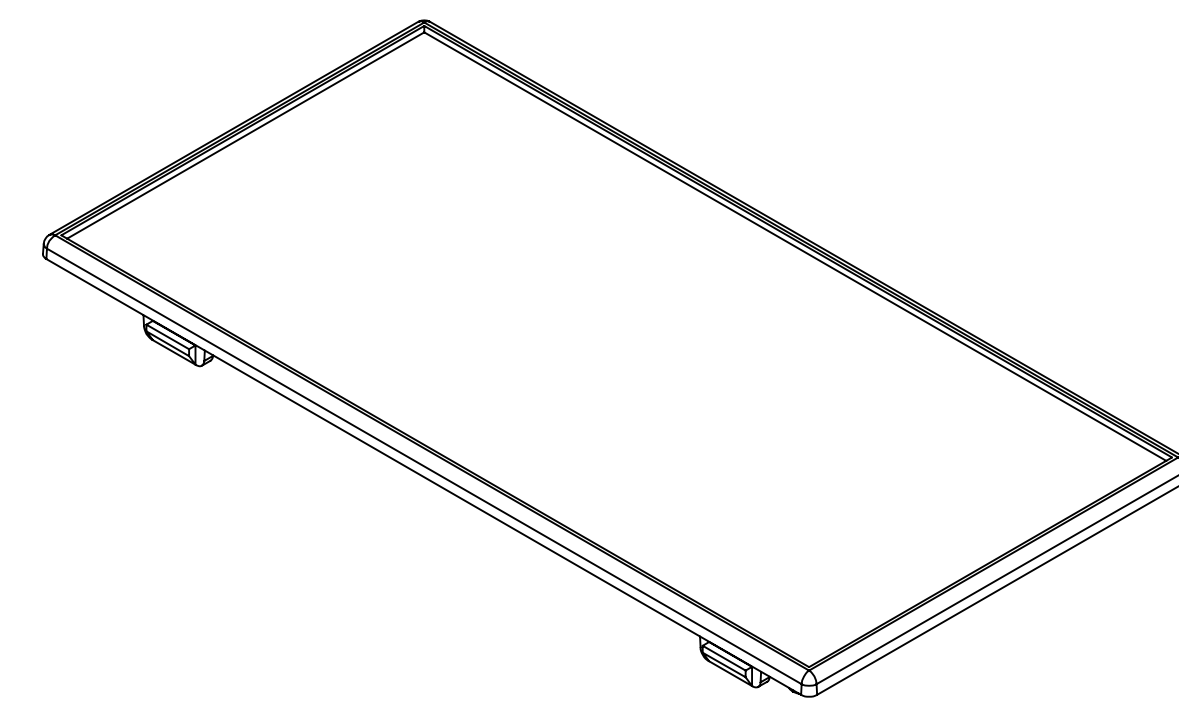

# BASE: 6 SURFACE

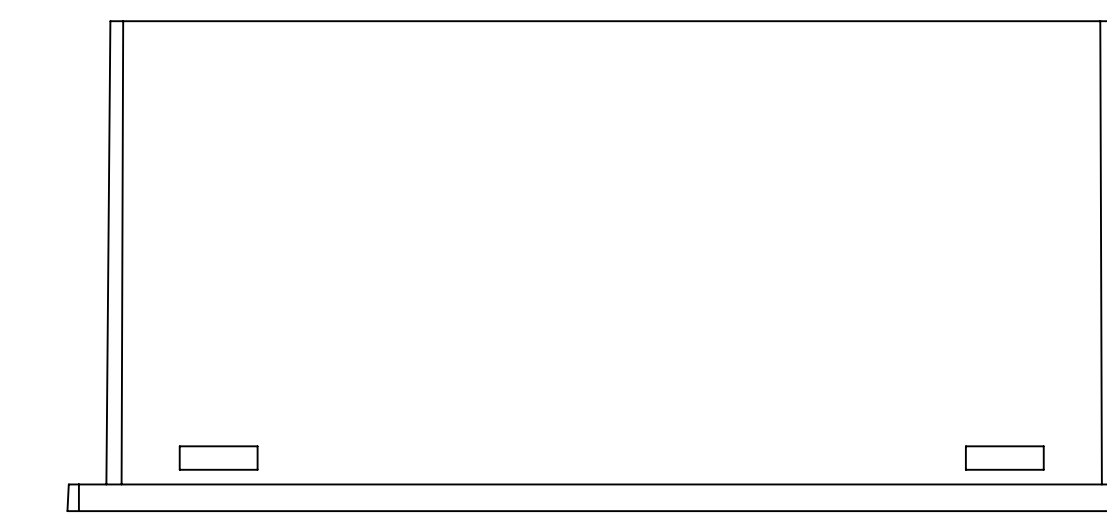

SURFACE-7

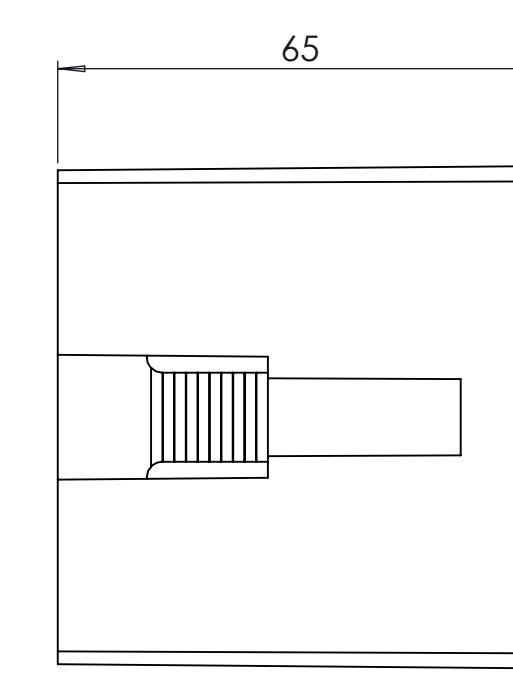

SURFACE-9

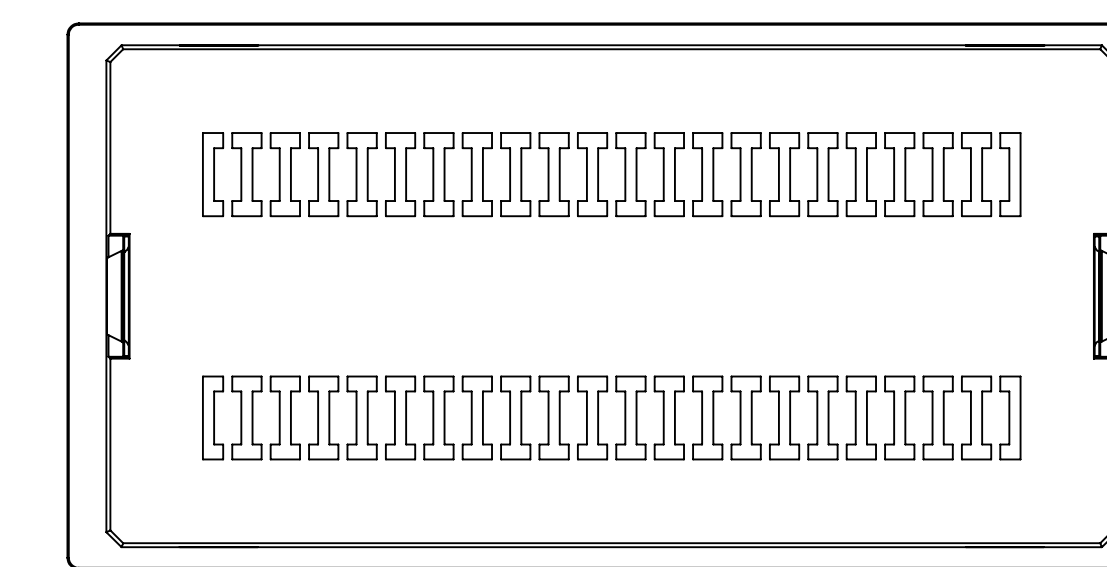

SURFACE-11

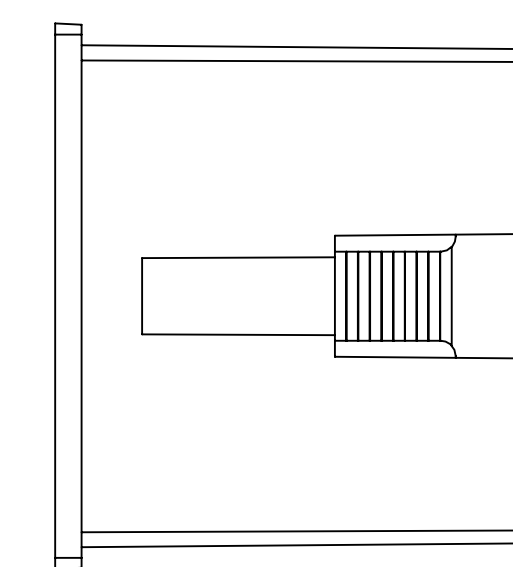

SURFACE-10

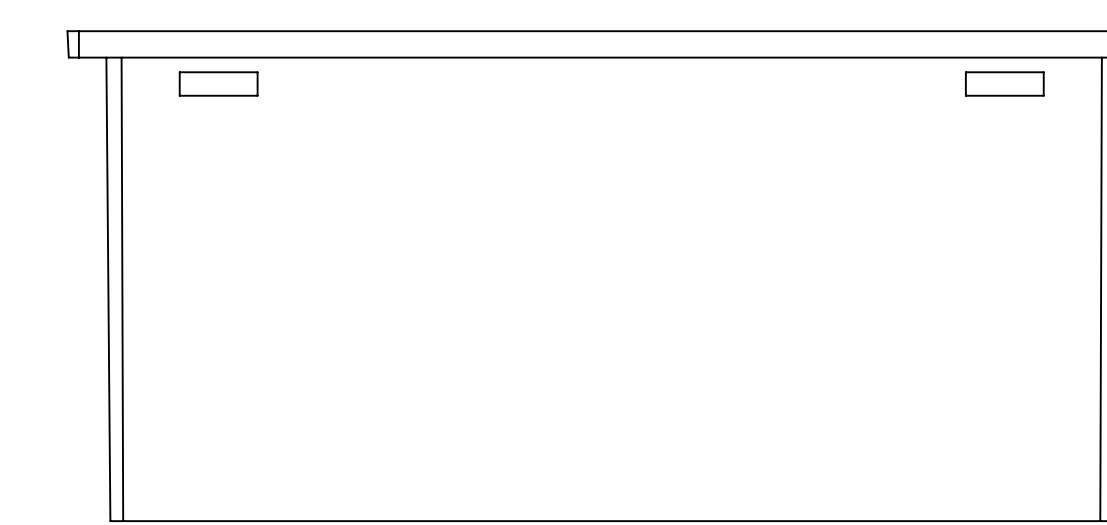

SURFACE-8

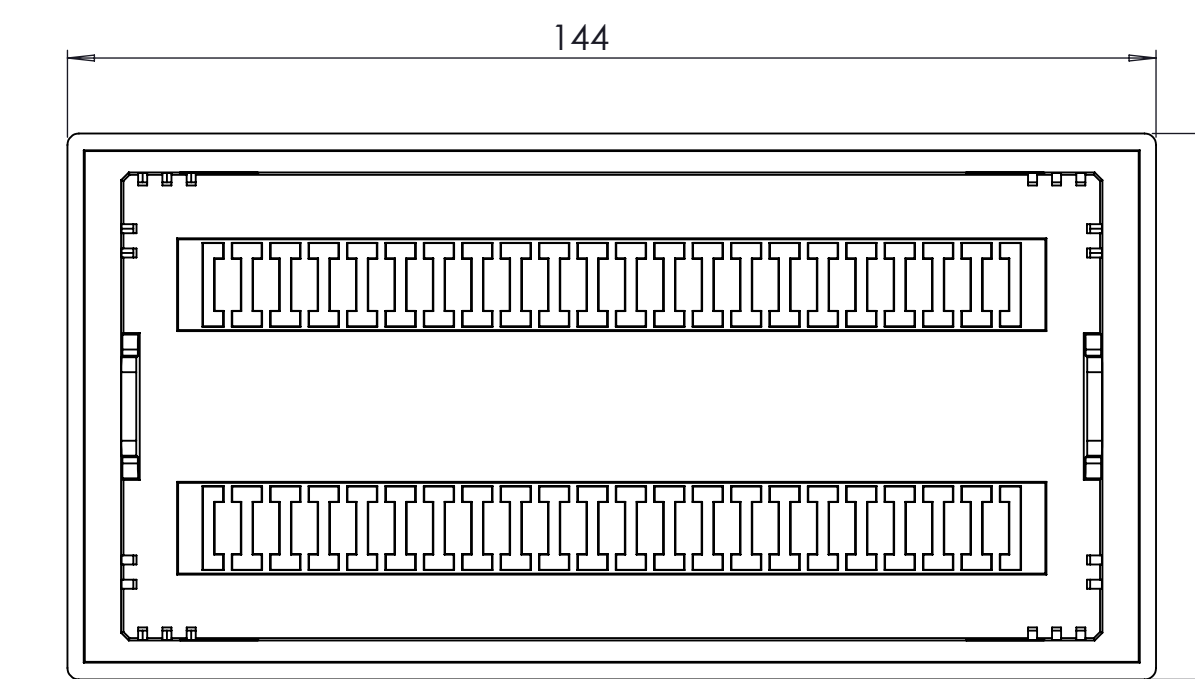

SURFACE-12 (INSIDE)

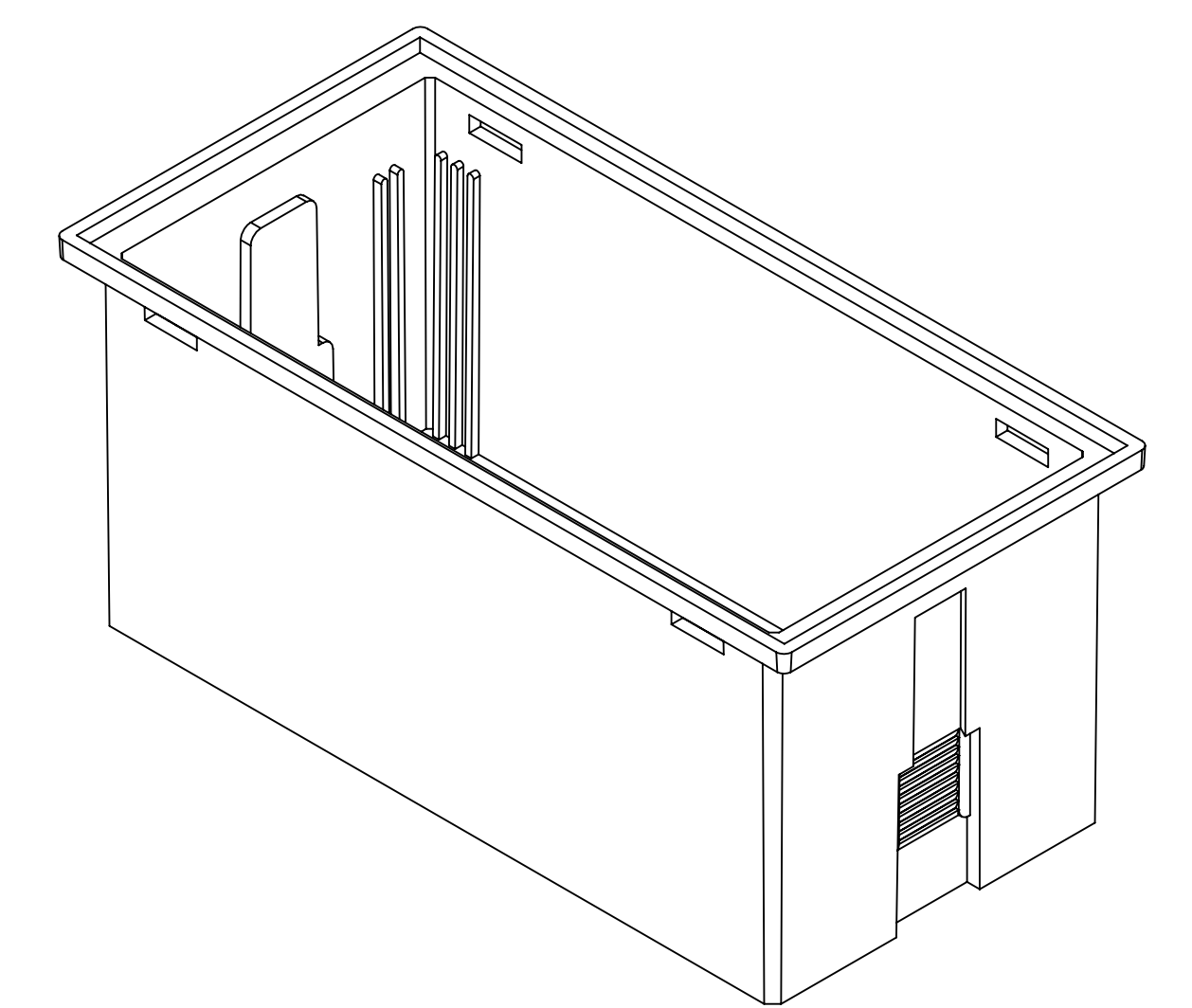

REV. NO	DATE	REVISED BY	DESCRIPTION OF CHANGE
 <b>ALTINKAYA</b> Electronic Enclosures & Components			<a href="http://www.altinkaya.com">www.altinkaya.com</a>
Customer Name:		Customer Ref.:	
Altinkaya Ref.:		Part Name: PT-205-01-0-0	
DRAWN	NAME	DATE	Drawn From:
CHECKED	Y.YEL	25.07.2025	Weight:
DIMENSIONAL TOLERANCES UNLESS OTHERWISE SPECIFIED (DIN7168)			
0.5-3mm	3-6mm	6-30mm	30-120mm
±0.1	±0.1	±0.2	±0.3
			120-400mm
			±0.5
			m (Medium)
			SCALE 1:1
			SHEET 1 OF 2
			UNIT: mm
			A0

# PT-205 IF MACHINED TOGETHER

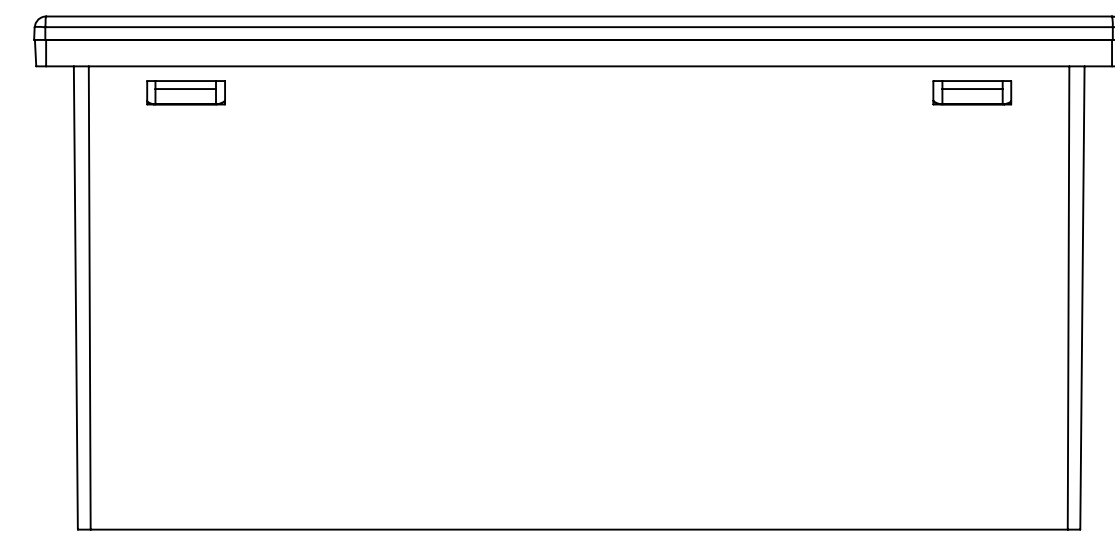

SURFACE-13

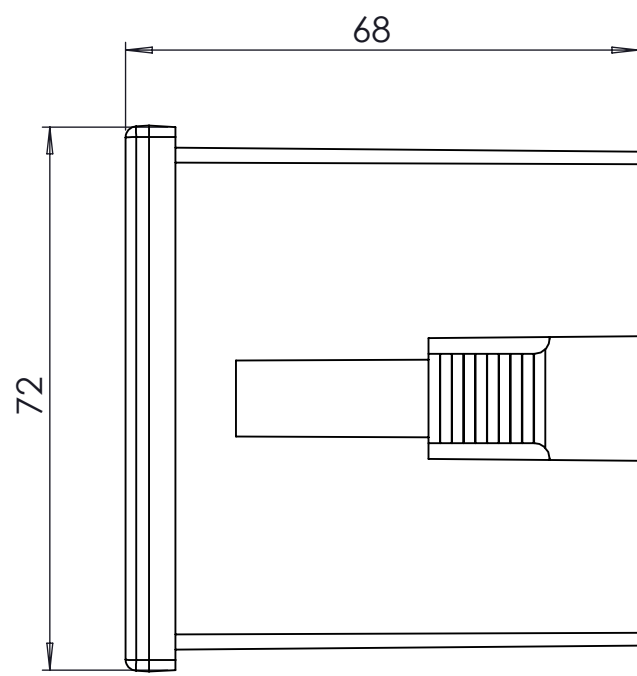

SURFACE-15

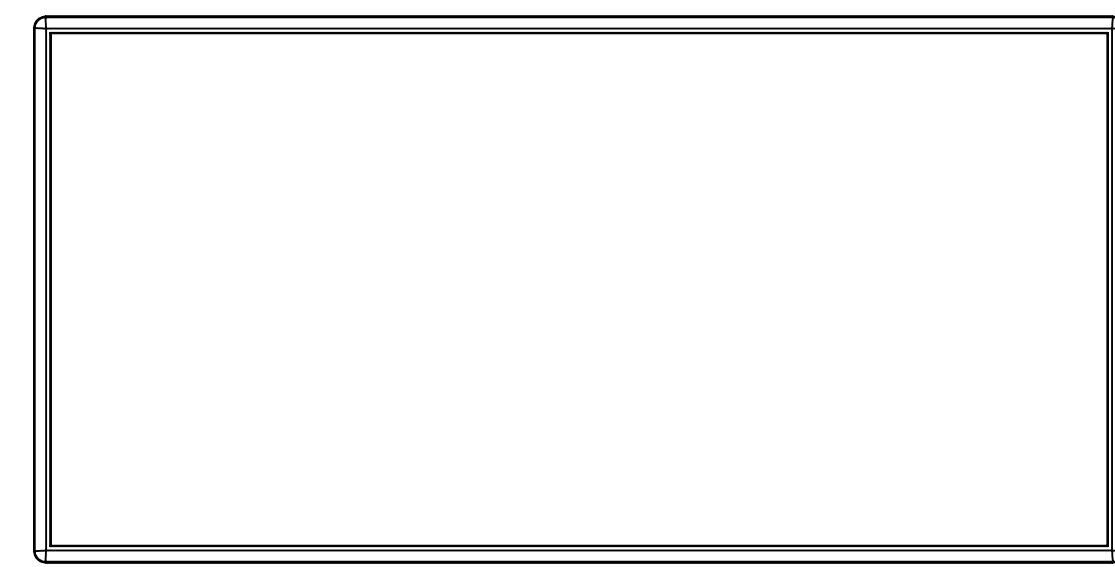

SURFACE-17

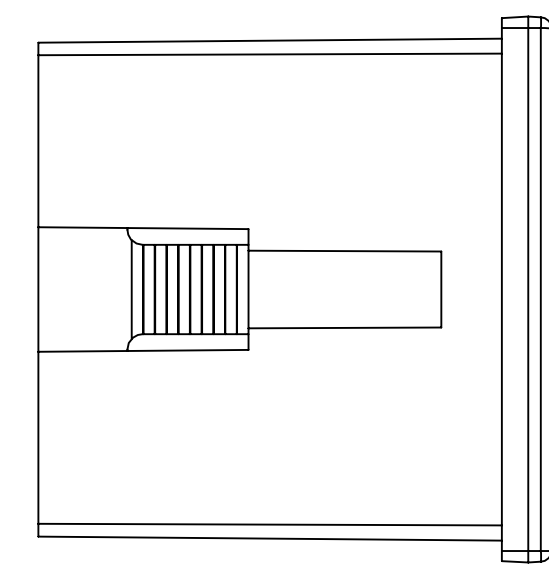

SURFACE-16

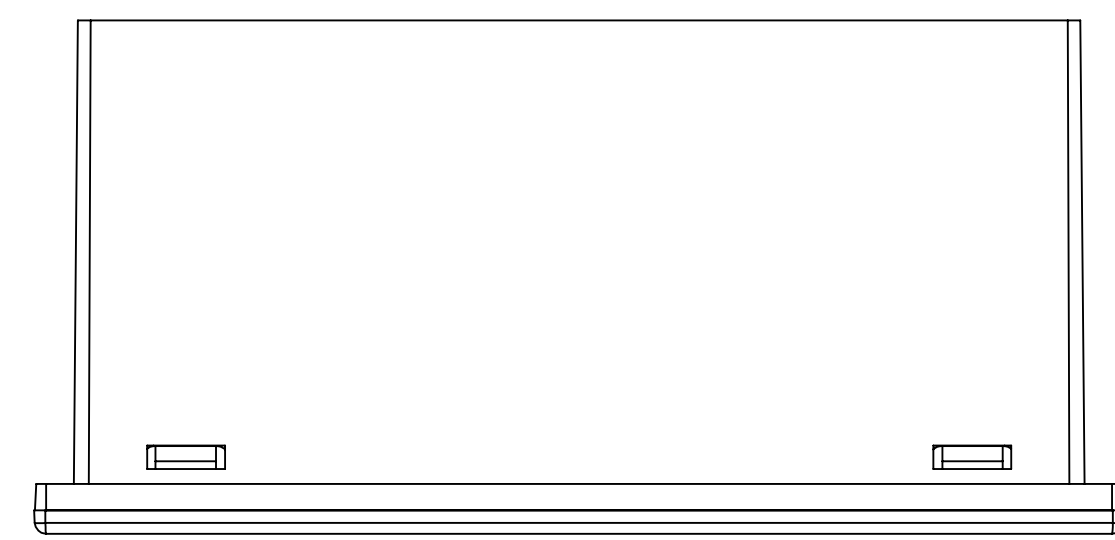

SURFACE-14

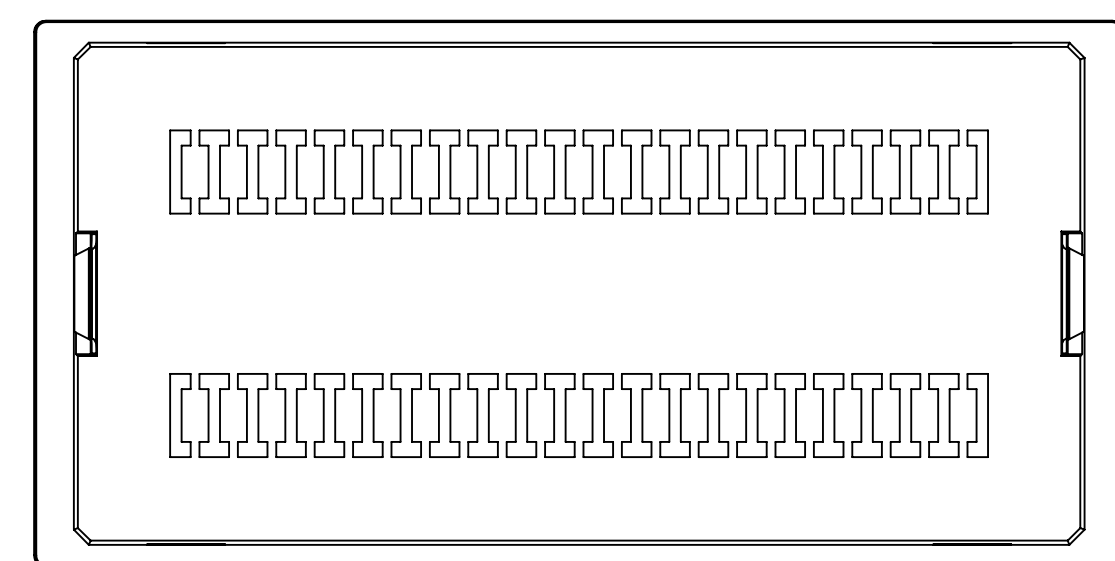

SURFACE-18

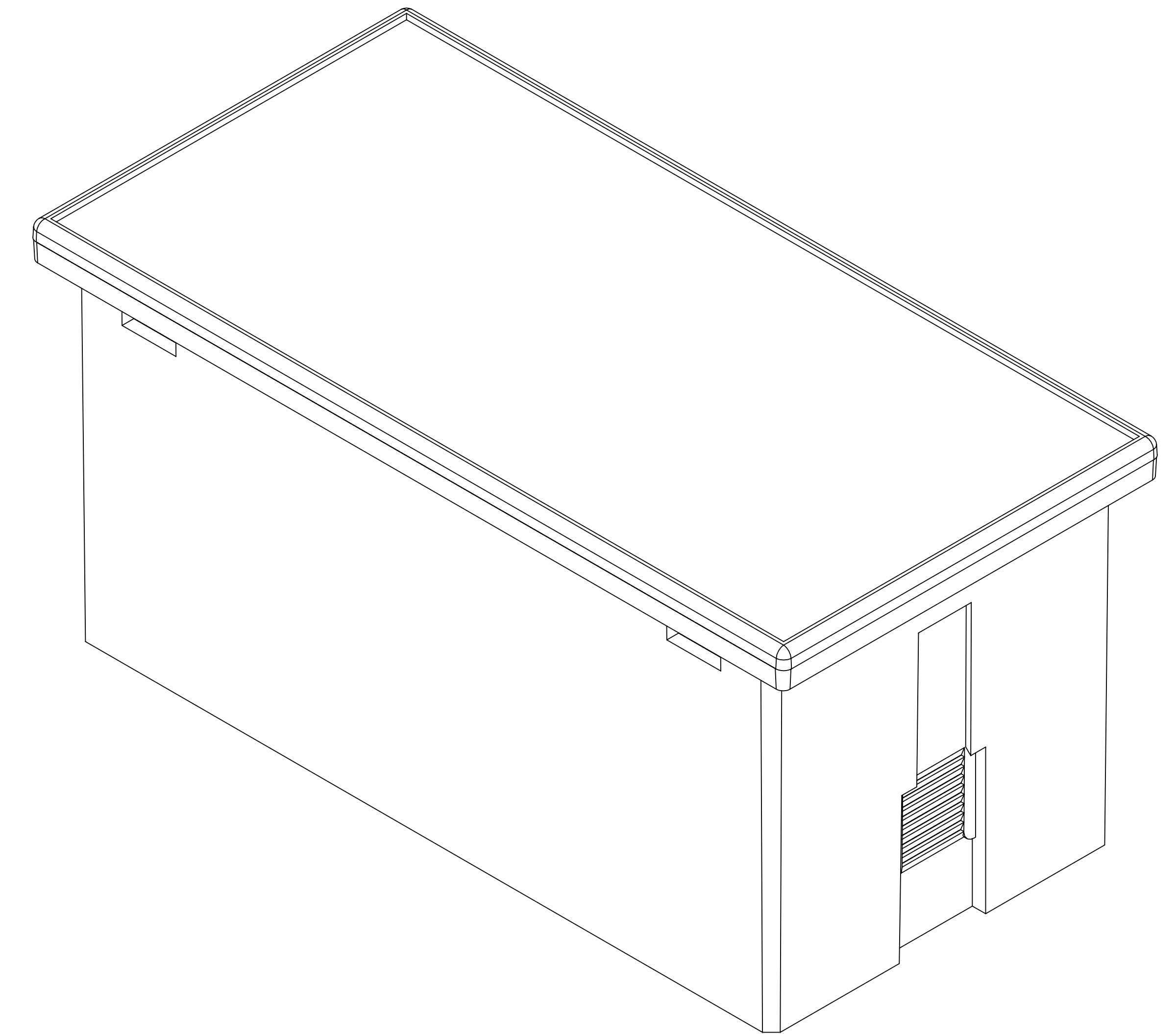
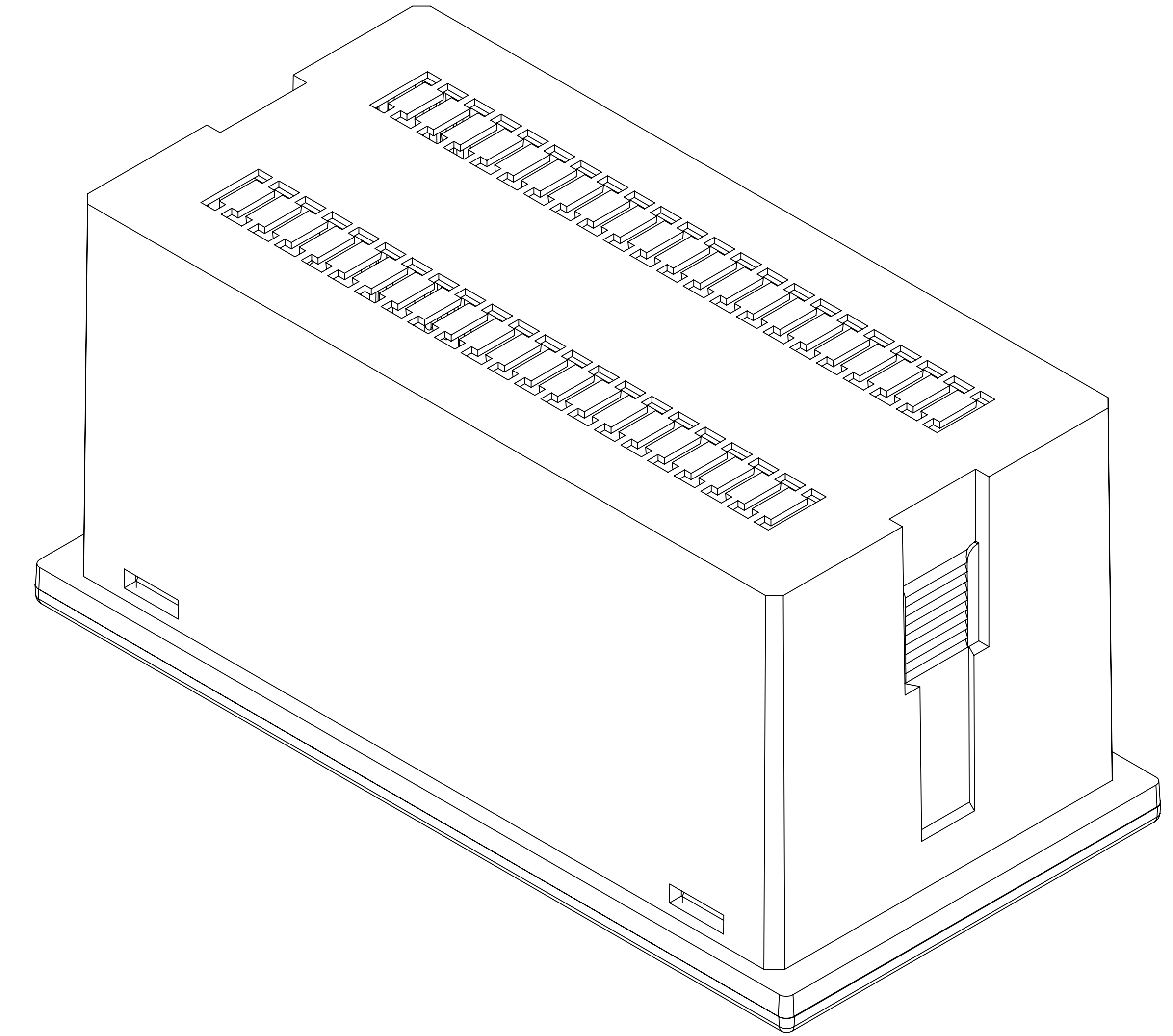

REV. NO	DATE	REVISED BY	DESCRIPTION OF CHANGE		
<b>ALTINKAYA</b> Electronic Enclosures & Components			<a href="http://www.altinkaya.com">www.altinkaya.com</a>		
Customer Name:		Customer Ref.:			
Altinkaya Ref.:		Part Name: PT-205-01-0-0			
DRAWN	NAME	DATE	Drawn From:	SCALE 1:1	
CHECKED	Y.YEL	25.07.2025	Weight:	SHEET 2 OF 2	
DIMENSIONAL TOLERANCES UNLESS OTHERWISE SPECIFIED (DIN7168)			0.5-3mm	3-6mm	6-30mm
			±0.1	±0.1	±0.2
			±0.2	±0.3	±0.5
			Dimension (mm)		
			m (Medium)		
			UNIT: mm		