

BASE: 6 SURFACE

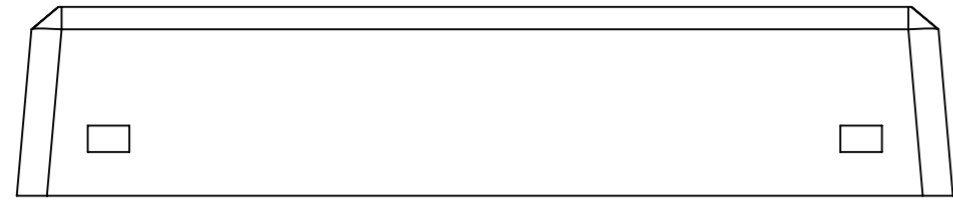

SURFACE-1

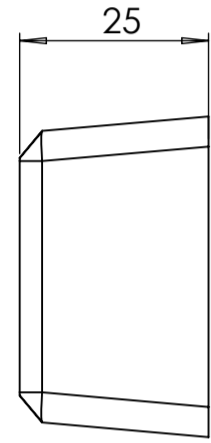

SURFACE-3

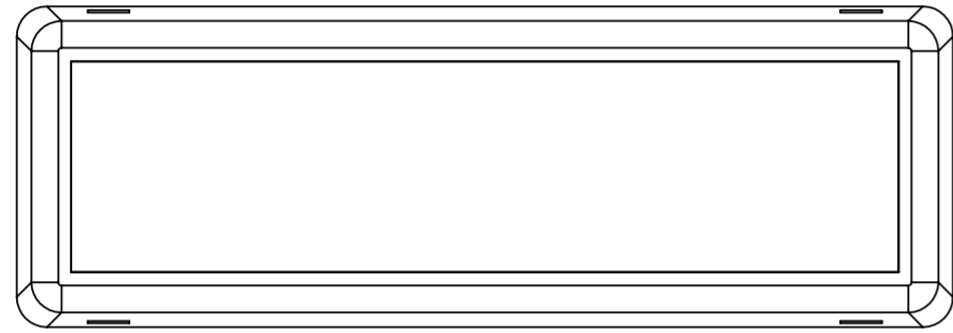

SURFACE-5

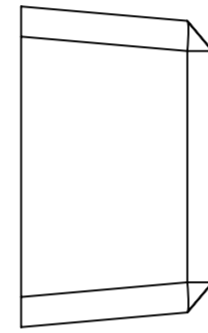

SURFACE-4

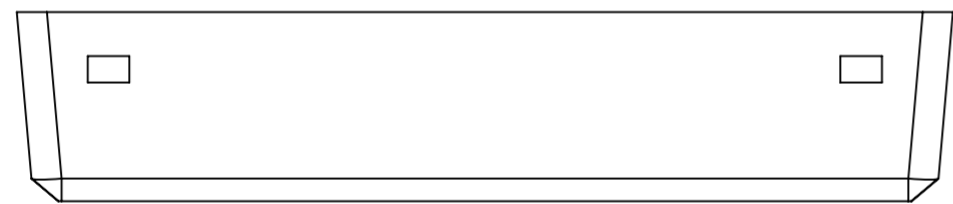

SURFACE-2

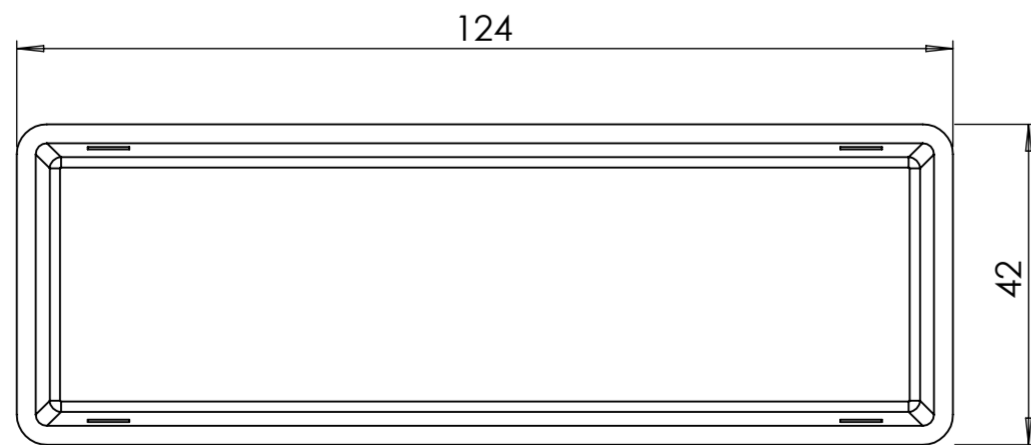

SURFACE-6 (INSIDE)

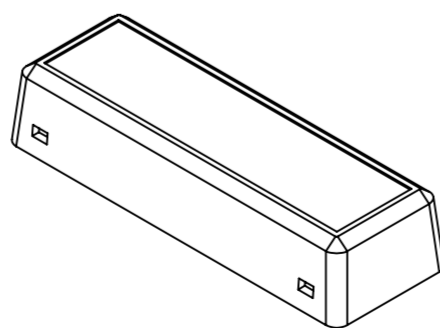

COVER: 6 SURFACE

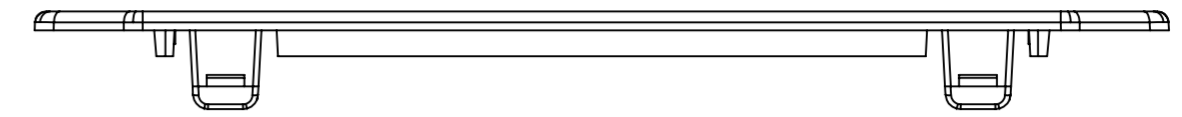

SURFACE-7

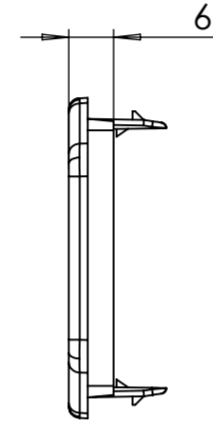

SURFACE-9

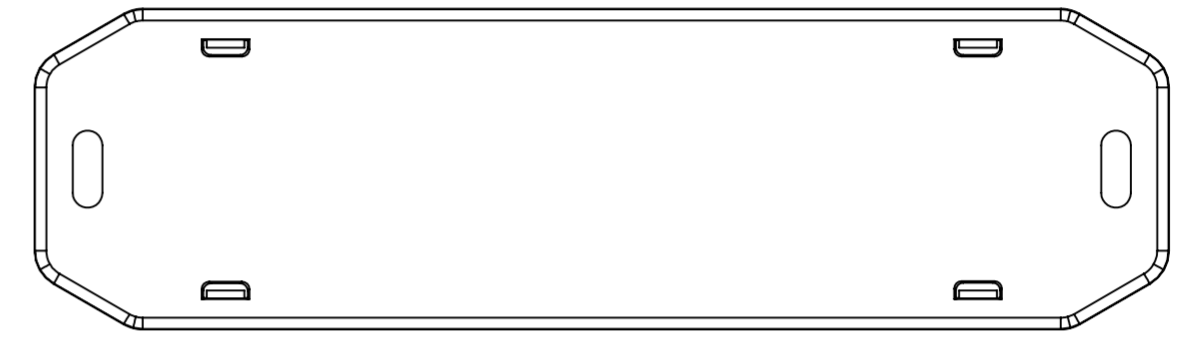

SURFACE-11

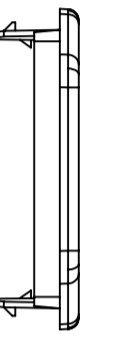

SURFACE-10

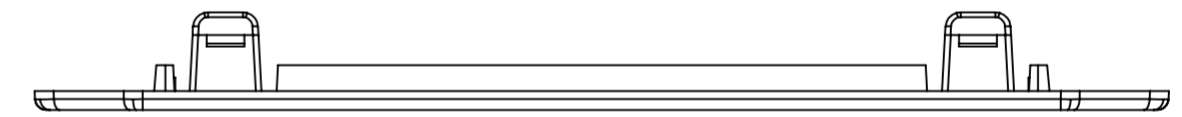

SURFACE-8

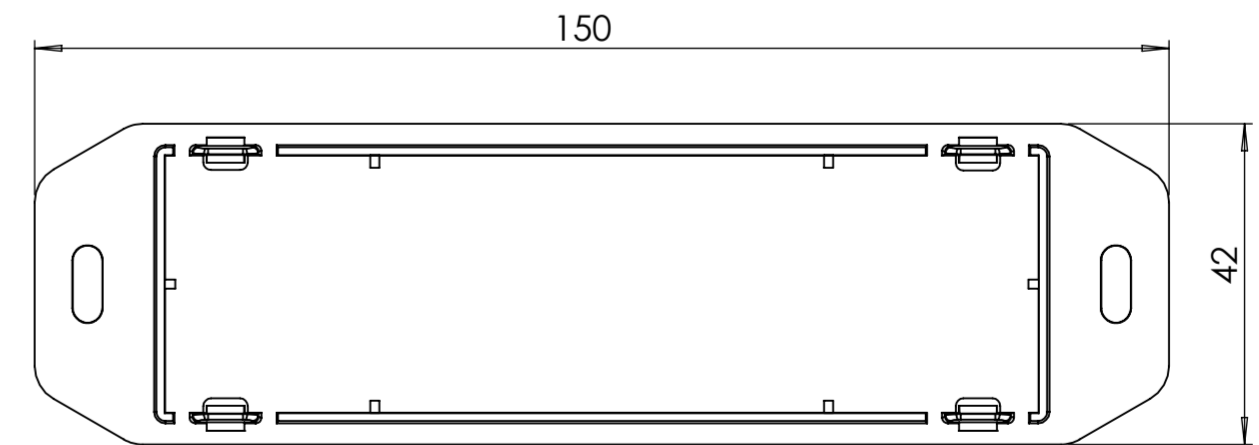

SURFACE-12 (INSIDE)

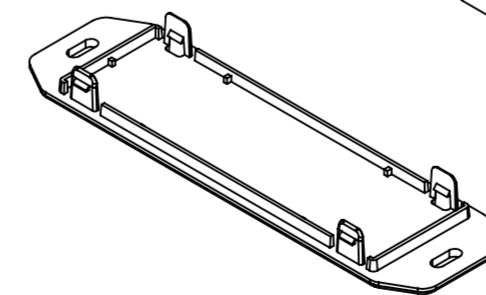

REV. NO	DATE	REVISED BY	DESCRIPTION OF CHANGE
 ALTINKAYA Electronic Enclosures & Components			
Customer Name:		Customer Ref.:	
Allinkaya Ref.:		Part Name: DM-026	
DRAWN	NAME	DATE	Drawn From:
CHECKED	Y.YEL	18.09.2024	Material:
DIMENSIONAL TOLERANCES (UNLESS OTHERWISE SPECIFIED (DIN 7148))			Weight:
	0,5-3mm	3-6mm	6-30mm
	±0,1	±0,1	±0,2
			±0,3
			±0,5
			m (medium)

SCALE: 1:1

SHEET 1 OF 2

A2

DM-026 MACHINED TOGETHER

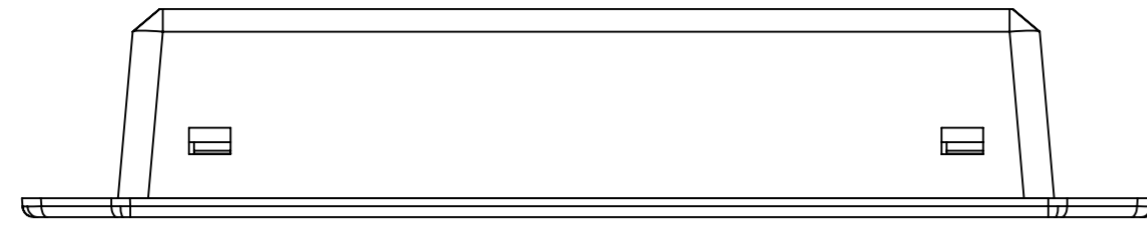

SURFACE-13

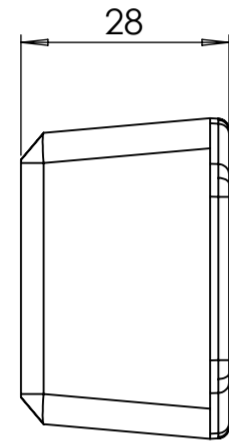
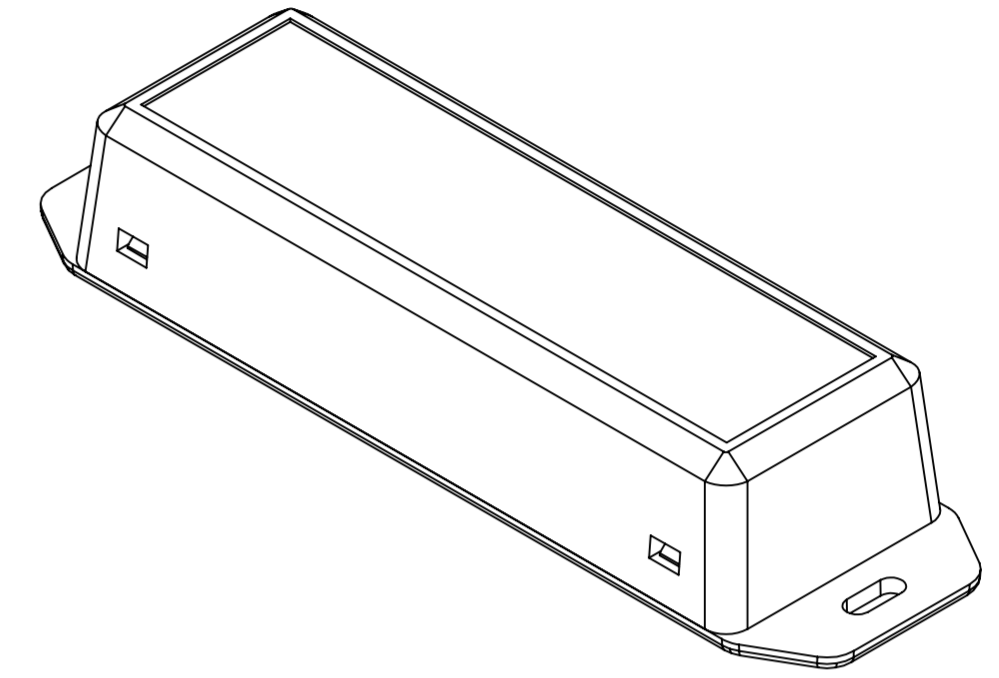

SURFACE-15

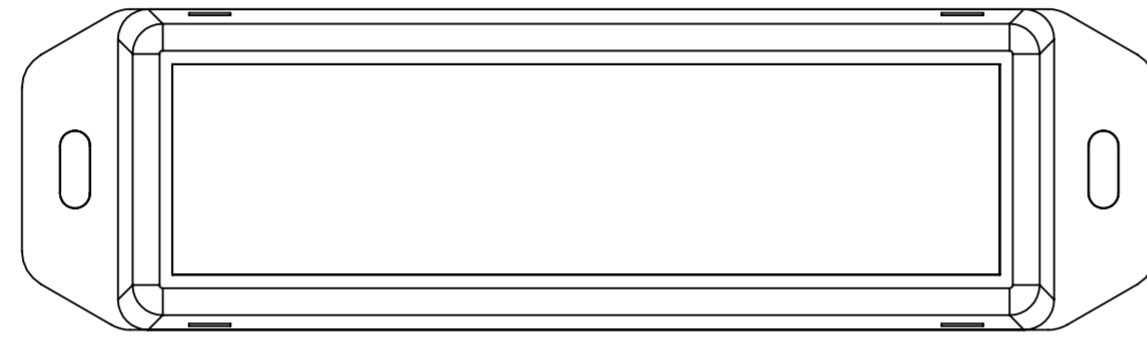

SURFACE-17

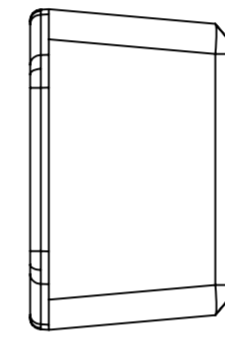

SURFACE-16

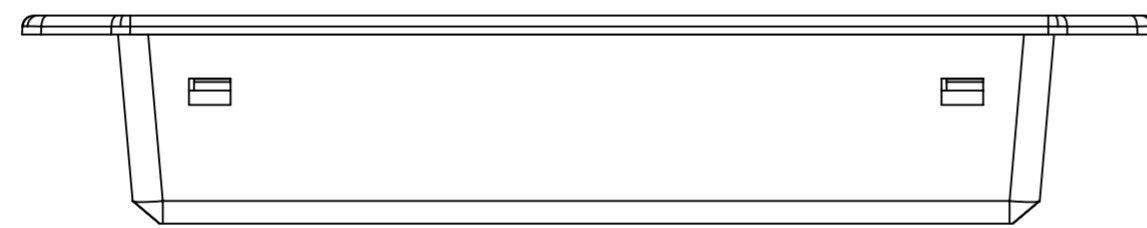

SURFACE-14

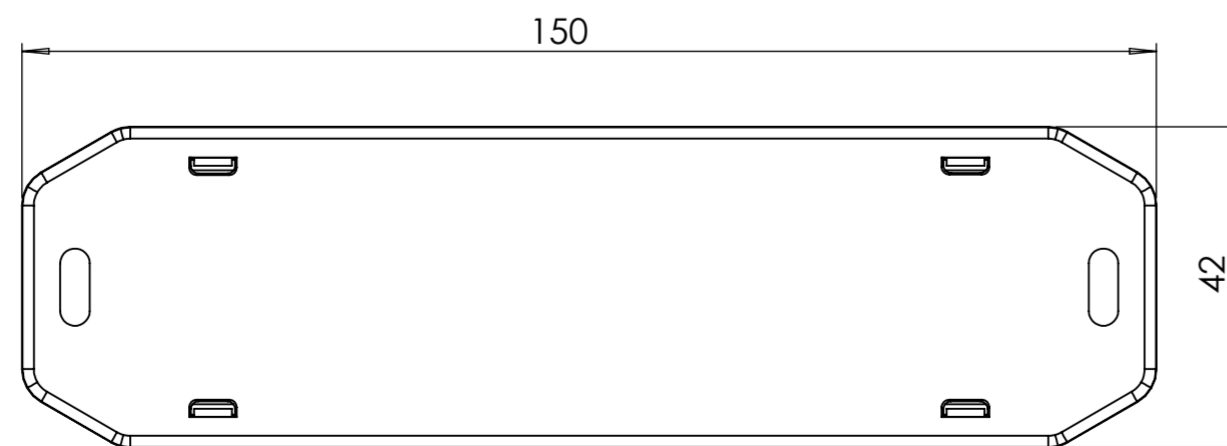
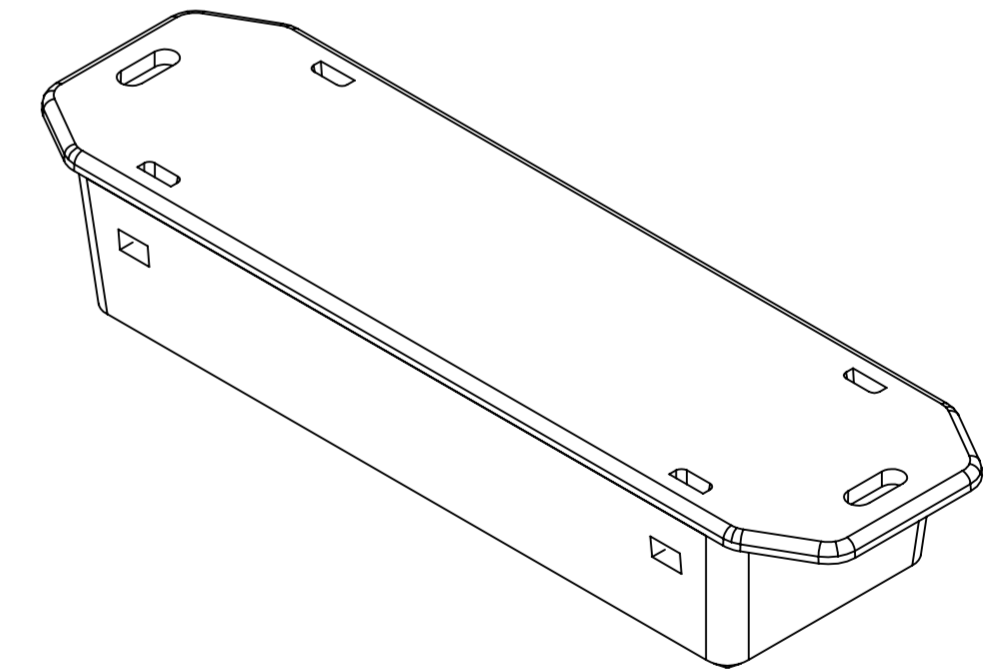

SURFACE-18

REV. NO	DATE	REVISED BY	DESCRIPTION OF CHANGE
ALTINKAYA Electronic Enclosures & Components			www.altinkaya.com
Customer Name:		Customer Ref.:	
Altinkaya Ref.:		Part Name: DM-026	
DRAWN	NAME	DATE	Drawn From:
CHECKED	Y.YEL	18.09.2024	Material:
DIMENSIONAL TOLERANCES UNLESS OTHERWISE SPECIFIED (EN 7148)		0,5-3mm	3-6mm
		6-30mm	30-120mm
		20-400mm	Dimension (mm)
		±0,1	±0,1
		±0,2	±0,3
		±0,5	mm (medium)
SCALE: 1:1			SHEET 2 OF 2